

 NETRO

STREAM

Smart Indoor Watering System

User Manual

Meet the Watering System of the Future

For user manuals in other languages, please visit
netrohome.com

Meet Stream, the Smart Indoor Watering System

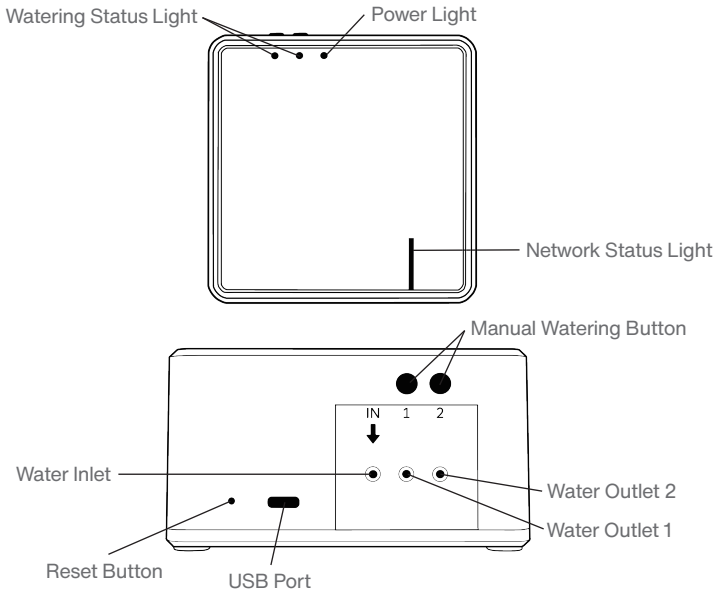

The Netro App

- 1** Download the Netro app. If you do not have the Netro app on your mobile device, search for Netro and download the free Netro app in the Google Play store or App Store.
- 2** Launch the Netro app. Create a Netro account or log in with an existing Netro account to start setting up the pump. If you are using other Netro products, you do not need to create another account, instead you can add your pump to the same account.

Setup the pump in the app

- 1** Plug in the power of the pump to turn it on.
- 2** The Network Status Light will flash in blue, indicating that it is ready for the network connection.
- 3** Make sure the pump stay close to your router, and follow the steps in the Netro app to add your pump to your Netro account.

Install the pump

1 Please connect the pump to the tubing, and you can realize multiple-pot irrigation through multi-way connectors according to your personal needs. You can close unnecessary outlets with plastic plugs, and please use a filter at the water inlet to filter impurities in the water.

Tips: it is recommended to choose a small opening water container to prevent garbage and dust from falling out.

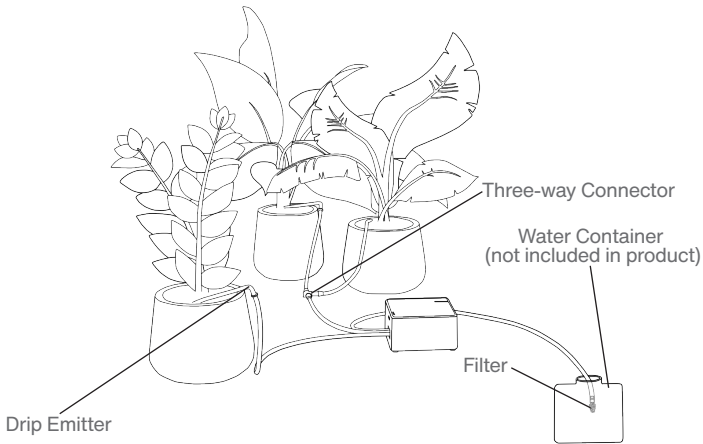

Install the pump

Here are two common irrigation connection methods (Water Outlet 1 is taken as an example), and you can combine it according to your actual needs.

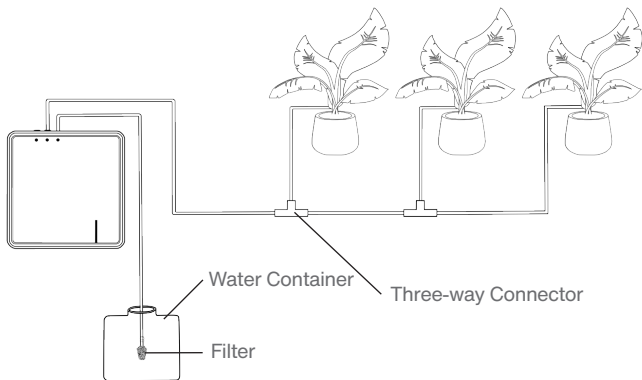

Example One

Install the pump

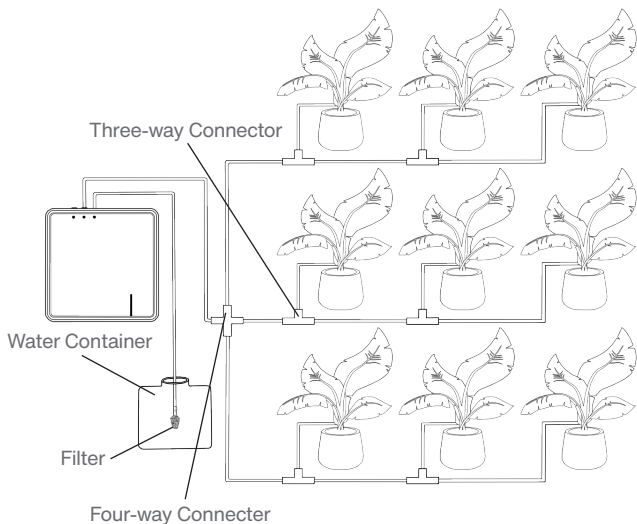

Example Two

Install the pump

To prevent siphoning, if possible, place the water container below the potted plants. If not feasible, ensure the water container is at the same level as the potted plants.

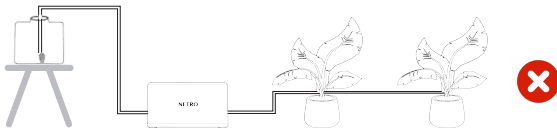
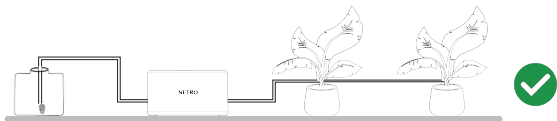
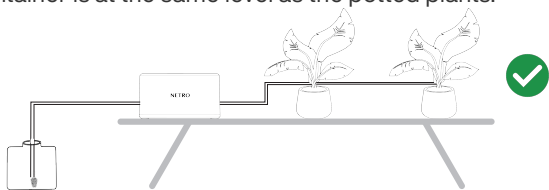

Install the pump

2 Test the WiFi signal (if the pump is displaced, these steps can be performed to ensure that the network is connected)

1. If the pump is not plugged in the power, press the reset button shortly (less than 1 second) to turn off the pump when it is in the power-on state. After 10 seconds, press the reset button shortly again (less than 1 second) to turn on the pump. If the pump is plugged in the power, press the reset button shortly (less than 1 second) to restart the pump.
2. The pump will try to reconnect to the network.
3. Wait for 15-30 seconds.
4. If the network connection is successful, the Network Status Light will show solid green.
5. If the network connection fails, the Network Status Light will show solid red, and you may need to move the pump closer to the router to try to reconnect (generally, the distance should be kept within 30 meters).

3 Press the Manual Watering Button twice in the power-on state quickly to test whether the pump is working properly. Press the Manual Watering Button twice in the power-on state quickly again to stop watering.

4 When not plugged in, the pump will enter sleep mode after 3 minutes (5 minutes when not connected to the Internet) to save power.

Battery

Your Stream is powered by a rechargeable advanced lithium battery which is charged through the USB port.

Tip: 3 hours of charging can generally provide 1-2 weeks of normal operation.

Watering Status Light

Stream's Watering Status Light has two displays:

Solid blue: the pump is watering.

Flashes in blue (flashes once every 0.5 seconds): the pump is idling, please check if there is a lack of water.

Power Light

Stream's Power Light has three displays:

Solid red: the pump is charging.

Flashes in red (flashes once every 15 seconds): the battery power is low.

Go out: when charging is completed, the red light will go out.

Network Status Light

Stream's Network Status Light has five displays:

Solid white: this means the pump is trying to connect to your home WiFi. It will change into solid green or solid red within 30 seconds.

Solid green: the pump has connected to the network.

Flashes in green (flashes once every 0.5 seconds): this means the pump have been communicated with the cloud server.

Red (remain solid for 10 seconds): the pump fails to connect to the network, and it will enter Bluetooth Pairing Mode after 10 seconds.

Flashes in blue (flashes once every 0.5 seconds): the pump is in a Bluetooth Pairing Mode.

Solid blue: the pump has been connected via Bluetooth.

Yellow: the pump has been restored to factory settings.

Manual Watering Button

Stream's Manual Watering Button has three executable operations:

Start-stop of manual watering : pressing the Manual Watering Button twice quickly when the pump is powered on, the pump will start watering. The default watering time is 1 minute , and if you want to stop watering earlier, please press the Manual Watering Button twice quickly again.

Wake up the pump: when the pump is in a sleeping mode, press the Manual Watering Button shortly (less than 1 second) will wake up the pump.

Reset Button

Stream's reset button has two executable operations:

Restart: when plugged in the power, press the reset button shortly (less than 1 second) will restart the pump. The pump will try reconnecting the Internet in the power-on state.

Power-on: press the reset button shortly (less than 1 second) in the power-off state will power on the pump. When powered on, the pump will try to reconnect the Internet.

Power-off: when the pump is in the power-on state and not plugged in, press the reset button shortly (less than 1 second) will power off the pump. When powered off, the pump is unavailable.

Restore factory settings/reconfigure WiFi: press and hold the reset button for 6 seconds in the power-on state, the Network Status Light will turn yellow, and the pump will restore factory settings and enter Bluetooth Pairing Mode. If you need to initialize all settings of the pump in the Netro app, please remove the pump from the app before performing operations above.

Device Status Explanation

Operating Status

Power-off: the pump cannot work. Please press the reset button shortly (less than 1 second) or plug in the power to turn on the pump.

Power-on: the pump is running and can start watering at any time.

Sleeping: the pump is in sleep, and all indicators will go out. If you need to perform manual operation, you need to wake it up first.

Plugging in the power or pressing the watering button shortly (less than 1 second) will wake up the pump.

Power Status

Charging: the pump is charging, and the Power Light is in solid red.

Charged: the battery is fully charged and the Power Light will go out.

Discharging: the pump is in use, so the battery power will gradually decrease, and the Power Light is off.

Low-battery: the battery power is low, and the Power Light flashes in red (flashes once every 15 seconds).

Network Status

Bluetooth Pairing Mode: the Network Status Light flashes in blue, waiting for Bluetooth connection.

Online: the pump is connecting to the network, and the Network Status Light is in solid green.

Offline: the pump fails to connect to the network, and the Network Status Light is in solid red. The pump will enter Bluetooth Pairing Mode after 10 seconds.

Irrigation Status

Watering: the pump is watering, and the Water Status Light is in solid blue.

Exception: the Water Status Light flashes in blue for 5 seconds. This may be caused by lack of water.

Power-on and Power-off

Power-on: press the reset button shortly (less than 1 second) or plug in the power to turn on the pump. If the pump cannot be started by pressing the reset button, it may be caused by low-battery. Please plug in the power supply to start the device.

Power-off: when the pump is in the power-on state and not plugged in the power, press the reset button shortly (less than 1 second) will power off the pump. When powered off, the pump is unavailable.

Tip: How to save an idle pump?

Press the Manual Watering Button twice quickly to make the pump idle to drain the residual liquid in the motor. At this moment the water shortage alarm of the pump can be ignored, and then power-off the pump.

Accessories

Tubing: connects to the water inlet, water outlet, three/four-way connectors, plastic/metal plug, and drip emitters directly for water transportation.

Tip: the tubing has resilience, though, but in order to prevent the tubing from falling off at the joint due to water pressure, please cut off the tubing at the joint part each time you reconnect the tubing to ensure that the tubing always has preferable resilience.

Three/four-way Connectors: connect to the tubing to create multiple irrigation paths.

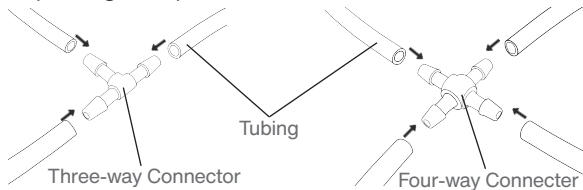

Metal Filter: connects to the tubing of the water inlet, used to filter impurities in the water to avoid blocking of the pump and tubing.

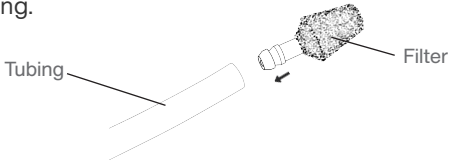

Accessories

Plastic Plugs: connect to the tubing of the outlet and is used to close the excess irrigation path. It will be more convenient for you to expand your irrigation system if you purchase additional potted plants in the future.

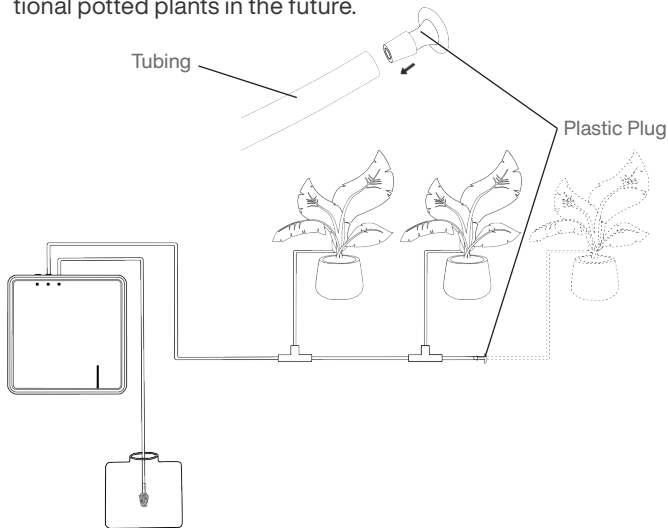

Accessories

Standard-flow Drip Emitters: when watering two or more potted plants with each outlet, please use a standard-flow drip emitter to connect the tubing. Insert the drip emitter into the soil for precise and even watering.

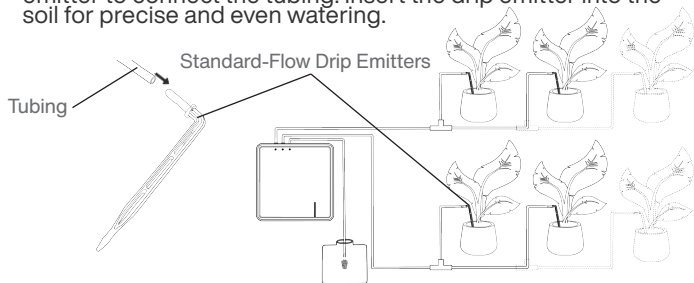

Large-flow Drip Emitters: when watering one potted plant with each outlet, the great water pressure may reduce the life of the pump. In order to avoid it, please use a large-flow drip emitter to connect the tubing. Insert the drip emitter into the soil for precise and even watering.

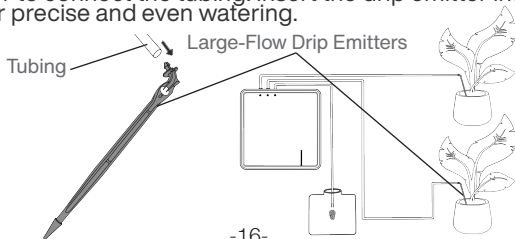

Accessories

Holder: installs it at the bottom of the pump, using to fix the pump on some planes or curved surfaces.

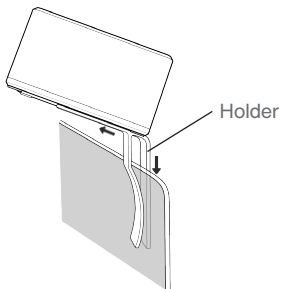

Mechanical Specifications

Model No.: STREAM

Dimensions: 4.1X4.1X2.2inches

Weight: 11.6 oz/330 g

Battery: 3.7V 1800mA

USB charging current: 600mA

Tubing size: 4 mm (Inner diameter)

Operating temperature range: 32 to 122°F / 0 to 50°C

Box contains: irrigation pump*1, filter*1, plastic plugs*4, standard-flow drip emitters*16, large-flow drip emitter*2, three-way connectors*16 four-way connectors*4, power adapter and cable*1, holder*1, tubing (inner diameter 4 mm; outer diameter 6 mm)*60feet, instructions

WiFi: 802.11 N, 2.4Ghz, US / Japan / EU

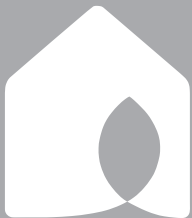

Netro INC.