



SPRITE

Smart Watering Controller
Quick start guide

- English - Français - Español -
- 简体中文 - Deutsch - Italiano - Português -

Meet the Watering System of the Future

For user manuals in other languages, please visit
netrohome.com

Contents



Controller

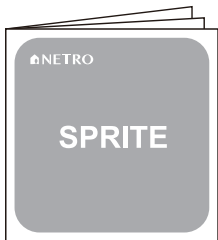

Instructions

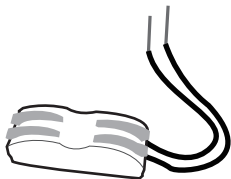

Wire connector

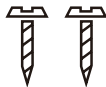

2 Screws

Preparation

- 1** Test the functionality of your irrigation system with your current controller first. If it does not work, please make sure it is repaired before installing the Sprite.

Note: If you are not sure about the condition of your sprinkler system, you might want to check whether there are shorted zones or open zones. You just need to use a multimeter to measure the resistance between the common wire and each zone. The normal reading would be 20-60 Ohms. If the reading is less than 10 Ohms then you might have a shorted circuit in the solenoid and if it is larger than 80 Ohms you might have an open circuit. Please contact us or irrigation professionals for additional support.

- 2** Unplug the power of your current controller.

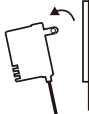

- 3** Take a photo of the wiring in your old controller. When you are wiring Sprite, this photo can be the reference.



- 4** Remove your current controller.

Installation

- 1** Check the strength of the WiFi signal at the location where your Sprite will be installed. We recommend a signal of at least 2 bars on your phone.

Note: Sprite is unable to connect to Wireless-B(11Mbps) routers. Sprite only supports the newer standards, namely Wireless-N, Wireless-G and Wireless-AC. Sprite is incompatible with 5 GHz Wi-Fi networks.

Also, please make sure the SSID (name of your home Wi-Fi) and the password does not contain special characters like spaces or quotation marks.

- 2** Remove the front cover from the base.



- 3** Install the Sprite base to the wall using the two screws included. Use the air bubble to position horizontally.

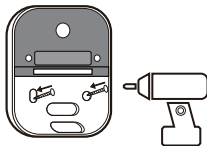

Wiring

4 Reconnect the wires to the slots on the base.

Tips:

1. Use the picture of the wires on your old controller to help you remember.
2. The slot named "M" is for the master valve or the pump. In some controllers it is named as "PMV" or "P/MV". If you do not have a master valve or a pump, you can leave this "M" slot unconnected.
3. If the old controller has only one common wire, you can connect it to either one of the "C" slots and the other "C" slot will sit empty.
4. If you want to use your old power adapter which has a ground wire, you can leave the ground wire open.
5. If the old controller is connected to a rain sensor, you do not need to connect the sensor wires because your Sprite obtains weather information from the WiFi network.

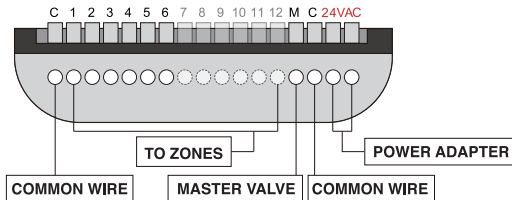

If you are not sure about the wiring, please send the picture of the wiring in the old controller to support@netrohome.com. Our customer service will provide quick support.

Wiring

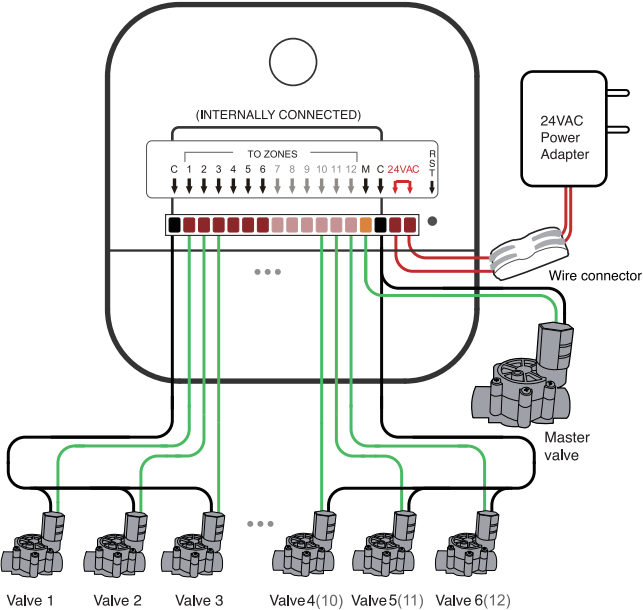

Setup

5 Put the front cover back on the base.



6 Plug in the power. Wait for 1-2 minutes, the light will be blinking slowly (once every second). If the light is stable or blinking fast (twice every second), press the RST button.

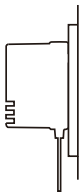

7 The network of your Sprite will be in its HOST mode (you will see a WiFi network named "Netro_IRC_xxx"). Please do not connect your phone to this Netro_IRC_xxx network right now. You will be asked to do so in step 8.

B Download the free Netro app and start to configure.

Tip:

Search for "Netro sprite watering" on Google Play and App Store.

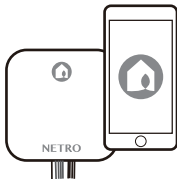

The LED Light

The LED light on your Sprite has three possible statuses:

Blinking slowly (on for a second and off for a second): this means the unit is in its HOST mode. This happens when you first plug in your Sprite or reset it, and indicates that it needs to go through the setup steps in the app to connect to a home WiFi network.

Solid: this means the unit is connected to your home WiFi.

Blinking quickly (on for 0.5 second and off for 0.5 second): This happens when you first set up your unit and did not enter the correct password, or whenever it loses its connection to the Netro cloud server.

The Reset Button

The reset button is located underneath the cover and is next to the AC adapter wiring slots. It is marked RST. You will need a pin or long, thin object to press the button.

Short press: to reset your Sprite to its HOST mode, simply press the button once for less than 1 second. Your Sprite should start blinking slowly in a few seconds.

Long press: to reset the unit to factory settings, hold down on the button for 6-8 seconds. Wait for 1-2 minutes, the light on your Sprite should start blinking slowly.

Troubleshooting

Sprite is unable to connect to my home Wi-Fi even if the correct password is entered.

1. It is possible that your WiFi router is too far away. We recommend a signal of at least 2 bars on your phone. It is also possible that your router is an old one and runs on Wireless-B (11Mbps). Sprite only supports the newer standards, namely Wireless-N, Wireless-G and Wireless-AC.
2. In the app, select WEP mode below the password field if your router is using WEP encryption.
3. Double check the password. You should enter the password of your home WiFi, not the password of your Netro account.
4. Make sure your router has access to the internet and it is not blocking port 1883 which is reserved for MQTT. Rebooting the modem might help.
5. Sometimes, rebooting your router can resolve some connection issues.

During the Wi-Fi setup, after I input the password, Sprite starts to blink quickly.

That means your Sprite is unable to contact the Netro server. It will disconnect from your router and change back to its host mode in a few seconds. Please see the above question for solution.

During the Wi-Fi setup, my phone cannot find the Wi-Fi network "Netro_IRC_XXX" hosted by Sprite.

Please press the RST button for less than 1 second, make sure Sprite is in host mode and the LED is blinking slowly(once per second).

Troubleshooting

During the Wi-Fi setup, my home Wi-Fi cannot be discovered.

Please make sure your router is turned on and has a signal of at least 2 bars on your phone at the location where your device is installed. Sprite only connects to 2.4 GHz Wi-Fi networks. You might also try to reboot your router.

The app says Sprite is watering but it is not opening the valves.

Please check the wires. Are they loose or disconnected from the slots? Please also check the common wires and the master valve if you have one. If you believe the wires are correctly installed, you might want to check whether there are shorted zones or open zones. You just need to use a multimeter to measure the resistance between the common wire and each zone. The normal reading would be 20-60 Ohms. If the reading is less than 10 Ohms then you might have a shorted circuit in the solenoid and if it is larger than 80 Ohms you might have an open circuit.

The light on Sprite is blinking fast (twice per second).

If your app shows the device is offline, your Sprite is unable to connect to your home WiFi (possible causes: 1. your router is down; 2. Wi-Fi signal is weak; 3. the SSID/password is changed) or the router has no access to the internet. If your app shows the device is online, you do not need to do anything. There was a network glitch when the device tried to get the watering schedules from the cloud server. The light will be back to steady when it updates the schedules successfully in an hour. Reboot your sprite (unplug and replug the power) if it does not.

How do I test the sprinkler system with Sprite?

There are two ways to test your sprinklers after installing Sprite: You can create an account and connect Sprite to your home Wi-Fi, then you can use the 'remote control' feature on the Netro app to turn on and off the zones instantly. If you just moved into a house and possibly have not installed the router, the "Test run" mode might work well for you: download the Netro app and use the "Test run" feature on the login page. In this way you do not need to have a home Wi-Fi or create a Netro account. Your phone is directly connecting to the Wi-Fi network hosted by the Sprite. This mode allows you to turn on and off the zones without involving the Netro cloud server.

Does Sprite work with rain sensors?

Sprite is not designed to support the traditional rain sensors because those rain sensors do not forecast rainfall. For example, you usually do not need to water your lawn if the rain is coming tomorrow but your rain sensors will not tell you that. Netro has more advanced technology including real-time weather information to be aware of the rainfall in the past and also in the future. For even more accurate watering schedules, Netro offers wireless moisture sensors which measure exactly how much water your plants need. We believe these innovations that Netro is built with are changing the way of home irrigation.

FAQ

What if I have more than 6(12) zones?

Consider adding another Sprite. The Netro app is capable of managing multiple controllers. You can link two controllers together. You will need to have at least two “common” wires so that each controller gets one. If there is only one “common” wire, it needs to be connected to both controllers by using a wire splitter.

Will Sprite re-connect to the Wi-Fi automatically after a power outage?

Sprite will re-connect to the Wi-Fi automatically after a power outage. Also, all the zone settings and watering schedules are saved on the cloud server, so you will not lose anything.

What happens if the Wi-Fi connection is lost, for example the router or the internet service is down?

Sprite will continue to execute the pre-loaded schedules for up to one month.

Can I use Sprite when I am away from my home Wi-Fi, for example on vacation?

Yes, as long as your phone/tablet has access to the internet, you can control and monitor your Sprite.

Specifications

Mechanical Specifications	
Dimensions	5.7X5.7X1.2 (1Inches)
Weight	8.2 oz / 230 g
Output	6 (12) zones + 1 master valve

Electrical Specifications	
AC Input	24VAC, 50 / 60 Hz, 800 mA
Valve output	24 VAC, 50 / 60 Hz, max 10VA
Master valve	24 VAC, 50 / 60 Hz, max 10VA
WiFi	802.11N, 2.4Ghz, US / Japan / EU
Indoor operating temperature range	-4° to 122°F / -20° to 50°C

Support

support@netrohome.com

FCC Compliance Notice and other legal information:
visit netrohome.com

Limited Warranty

Netro Inc., Portland, Oregon USA, warrants to the owner of the enclosed product that the product contained in the box will be free from defects in materials and workmanship for a period of two (2) years from the date of delivery following the original retail purchase. If the Product fails to conform to this Limited Warranty during the Warranty Period, Netro Inc. will repair or replace any defective product or component.

IMPORTANT INFORMATION ABOUT LIMITATIONS AND EXCLUSIONS

IN NO EVENT WILL NETRO BE LIABLE FOR ANY CONSEQUENTIAL, INCIDENTAL, EXEMPLARY, OR SPECIAL DAMAGES, INCLUDING ANY DAMAGES FOR LOST DATA OR LOST PROFITS, ARISING FROM OR RELATING TO THIS LIMITED WARRANTY OR THE PRODUCT, AND NETRO'S TOTAL CUMULATIVE LIABILITY ARISING FROM OR RELATED TO THIS LIMITED WARRANTY OR THE PRODUCT WILL NOT EXCEED THE AMOUNT ACTUALLY PAID FOR THE PRODUCT BY THE ORIGINAL PURCHASER.

SPRITE

Contrôleur d'arrosage intelligent

Guide de démarrage rapide

- Français -

Rencontrez le système d'arrosage du futur

Contenus



Contrôleur



Mode d'emploi

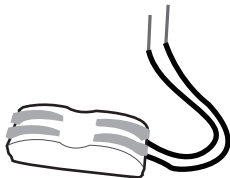

Connecteur de fil

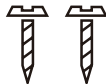

2 vis

Préparation

- 1** Commencez par tester la fonctionnalité de votre système d'arrosage avec votre contrôleur actuel. S'il ne fonctionne pas correctement, vérifiez votre installation avant d'installer le contrôleur Sprite.

Remarque: si vous n'êtes pas certain de l'état de votre système d'arrosage, il est recommandé de vérifier qu'il n'y a pas de court-circuit ou de fuite de courant. Vous aurez besoin pour cela d'un multimètre pour mesurer la résistance entre le fil Commun (généralement blanc) et chacune des bornes câblées représentant les différentes zones. Le multimètre devrait afficher une valeur entre 20 et 60 Ohms. Si le multimètre affiche moins de 10 Ohms, cela signifie qu'il y a un court-circuit dans la résistance ; s'il affiche plus de 80 Ohms, c'est qu'il y a une fuite de courant. Dans ce cas veuillez prendre contact avec nous ou bien avec un professionnel des systèmes d'arrosage pour une assistance supplémentaire.

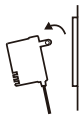

- 2** Débranchez votre contrôleur actuel.

- 3** Prenez une photo du câblage de votre ancien contrôleur, elle vous servira de référence lors de l'installation de votre contrôleur Sprite.



- 4** Sectionnez le disjoncteur du contrôleur, assurez-vous qu'il n'y ait plus de tension à l'aide d'un multimètre puis décâblez votre contrôleur actuel.

Installation

- 1** Vérifiez la portée du signal WiFi à l'endroit où vous souhaitez installer le Sprite.
Nous recommandons un signal d'au moins 2 barres sur votre téléphone.

Remarque: Le Sprite ne peut pas se connecter aux routeurs sans fil Wireless - B (11Mbps). Le Sprite ne reconnaît que les standards les plus récents, tels que Wireless-N, Wireless-G, et Wireless-AC. Le Sprite est incompatible avec les réseaux WiFi de 5 GHz.

De plus, assurez-vous que le SSID (le nom donné à votre WiFi) ainsi que le mot de passe ne contiennent pas de caractères spéciaux comme des espaces ou des guillemets.

- 2** Retirez le volet de protection.



- 3** Installez la base du Sprite au mur à l'aide des deux vis incluses dans votre kit. Utilisez un niveau à bulle pour la fixer de manière horizontale.

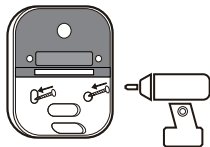

Branchement

4 Reconnectez les fils aux bornes de la base du Sprite.

Conseils:

1. Utilisez la photo du câblage de votre ancien contrôleur pour vous aider à câbler le nouveau.
2. La borne « M » est dédiée à la vanne principale ou à la pompe. Sur certains contrôleurs, elle porte les lettres « PMV » ou « P/MV ». Si vous n'avez ni vanne principale ni pompe à brancher, vous pouvez laisser cette borne « M » vide.
3. Si l'ancien contrôleur n'avait qu'un fil Commun, vous pouvez brancher ce dernier à l'une des deux bornes « C » (l'autre borne « C » restera vide).
4. Si vous souhaitez utiliser votre ancien adaptateur doté du fil de Terre, vous pouvez l'utiliser sans le brancher dans le boîtier.
5. Si l'ancien contrôleur est connecté à un capteur de pluie, il n'est pas nécessaire de brancher les fils du capteur car votre système Sprite reçoit les données météo par WiFi.

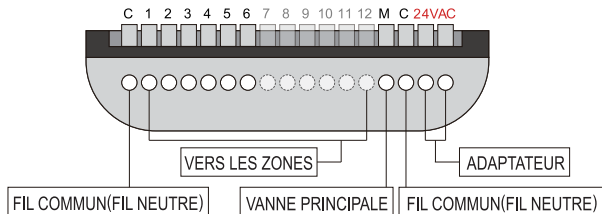

Si vous n'êtes pas sûr du câblage, veuillez envoyer la photo du câblage de l'ancien contrôleur à support@netrohome.com. Notre service client est là pour vous apporter une assistance rapide.

Branchement

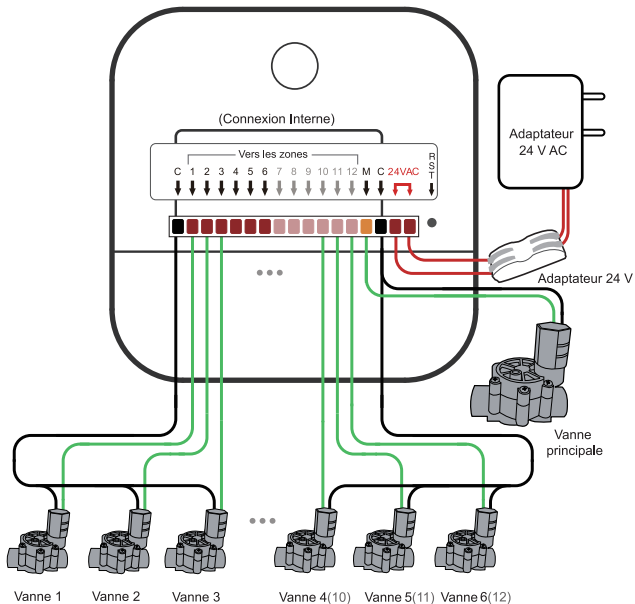

Installation

5 Remplacez le volet de protection sur la base.

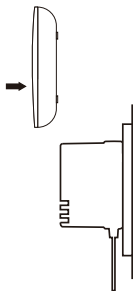

6 Branchez le contrôleur. Attendez 1 à 2 minutes, le voyant va clignoter lentement (un clignotement à la seconde). Si le voyant est continu ou s'il clignote rapidement (2 fois par seconde), appuyez sur le bouton RST.

7 Le réseau de votre système Sprite sera en mode Hôte (vous verrez apparaître un réseau WiFi appelé "Netro_IRC_xxx". Ne connectez pas tout de suite votre téléphone à ce réseau. Il vous sera demandé de le faire à l'étape 8 de l'installation.

8 Téléchargez l'application gratuite Netro, et commencez la configuration.

Conseil:

Recherchez "Netro sprite watering" dans Google Play et App Store.

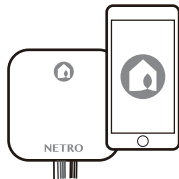

Le voyant LED

Le voyant LED sur votre contrôleur Sprite a trois états possibles :

Clignotement lent (allumé pendant une seconde et éteint pendant une seconde): cela signifie que l'unité est en mode hôte. Cela a lieu lors du premier branchement ou bien lors de la réinitialisation du Sprite ; pendant ce clignotement, le système passe par les différentes étapes de configuration de l'application pour se connecter à votre réseau WiFi.

Voyant continu: cela signifie que l'unité est connectée à votre réseau WiFi.

Clignotement rapide (allumé pendant $\frac{1}{2}$ seconde et éteint pendant $\frac{1}{2}$ seconde): cela signifie que vous avez rentré un mot de passe erroné lors de la première configuration ou bien que la connexion avec le serveur cloud Netro a été perdue.

Le bouton de réinitialisation

Le bouton de réinitialisation est situé sous le volet de protection et se trouve à côté de la prise pour l'adaptateur CA. Le bouton de réinitialisation est marqué des lettres RST. Vous aurez besoin d'une tige pointue, longue et fine pour pouvoir appuyer sur le bouton.

Appui court: pour réinitialiser votre Sprite à son mode Hôte, appuyez sur le bouton une seule fois et moins d'une seconde. Le voyant de votre Sprite devrait alors commencer à clignoter de manière lente quelques secondes plus tard.

Appui long: pour réinitialiser l'unité à ses paramètres d'usine, tenez le bouton appuyé pendant 6 à 8 secondes. Attendez 1 à 2 minutes, le voyant de votre Sprite devrait commencer à clignoter de manière lente.

SPRITE

Controlador de Rega Inteligente

Guía de inicio rápido

- Español -

Conheça o Sistema de Rega do Futuro

Contenido



Controlador

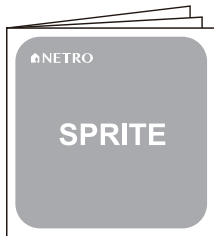

Instrucciones

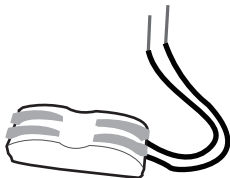

Cables

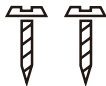

2 Tornillos

Preparación

- 1** Pruebe primero la funcionalidad de su sistema de riego con su controlador de corriente. Si no funciona, asegúrese de que esté reparado antes de instalar el Sprite.

Nota: Si no está seguro sobre el estado de su sistema de rociadores, es posible que desee comprobar si hay zonas en cortocircuito o zonas abiertas. Solo necesita usar un multímetro para medir la resistencia entre el cable común (generalmente blanco) y cada zona. La lectura normal sería 20-60 Ohms. Si la lectura es inferior a 10 ohmios, es posible que tenga un circuito cortocircuitado en el solenoide y, si es mayor de 80 ohmios, es posible que tenga un circuito abierto. Por favor contáctenos o a profesionales de riego para soporte adicional.

- 2** Desconecte la energía de su controlador de corriente.

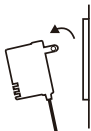

- 3** Tome una foto del cableado en su controlador anterior. Cuando este conectando a Sprite, esta foto puede ser la referencia.



- 4** Retire su controlador actual.

Instalación

- 1** Compruebe la intensidad de la señal WiFi en la ubicación donde se instalará su Sprite.
Recomendamos una señal de al menos 2 barras en su teléfono.

Nota: Sprite no es capaz de conectarse a enrutadores Wireless-B (11Mbps). Sprite solo es compatible con los estándares más nuevos, a saber, Wireless-N, Wireless-G y Wireless-AC. Sprite es incompatible con las redes Wi-Fi de 5 GHz. Además, asegúrese de que el SSID (nombre de su hogar Wi-Fi) y la contraseña no contengan caracteres especiales como espacios o comillas.

- 2** Retire la cubierta frontal de la base.



- 3** Instale la base de Sprite en la pared utilizando los dos tornillos incluidos. Use la burbuja de aire para posicionarlo horizontalmente.

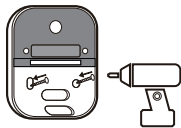

Cableado

4 Reconecte los cables a los terminales en la base de su Sprite.

Consejos:

1. Usa la imagen de los cables en tu viejo controlador para ayudarte a recordar su disposición.
2. La ranura llamada "M" es para la válvula maestra o la bomba. En algunos controladores, se le llama "PMV" o "P / MV". Si no tiene una válvula maestra o una bomba, puede dejar esta ranura "M" desconectada.
3. Si el controlador anterior tiene solo un cable común, puede conectarlo a cualquiera de las ranuras "C" y la otra ranura "C" se quedará vacía.
4. Si desea utilizar su adaptador de alimentación anterior que tiene un cable de tierra, puede dejar el cable de tierra abierto.
5. Si el controlador anterior está conectado a un sensor de lluvia, no necesita conectar los cables del sensor porque su Sprite obtiene información meteorológica de la red WiFi.

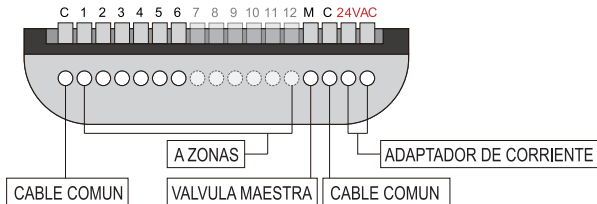

Si no está seguro acerca del cableado, envíe la imagen del cableado en el controlador anterior a support@netrohome.com. Nuestro servicio al cliente le brindará soporte rápido.

Cableado

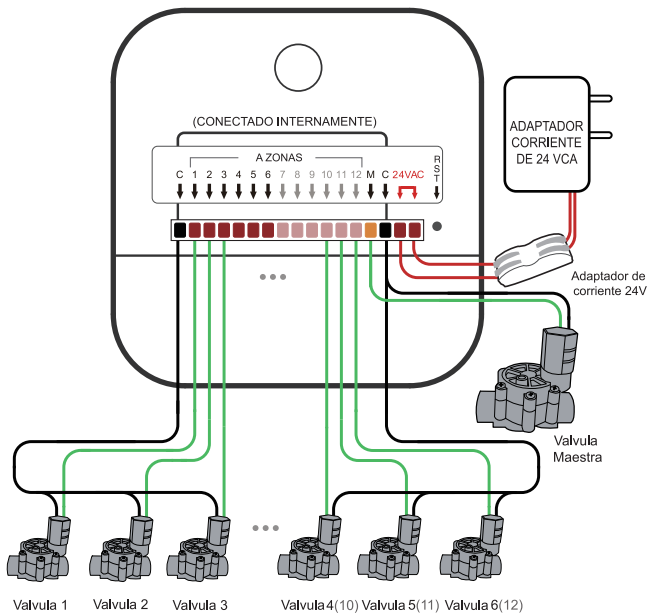

Instalación

5 Vuelva a colocar la cubierta frontal en la base



6 Conecte la corriente. Espere 1-2 minutos, la luz parpadeará lentamente (una vez por segundo). Si la luz es estable o parpadea rápidamente (dos veces por segundo), presione el botón RST.

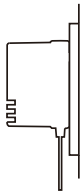

7 La red de su Sprite estará en su modo HOST (verá una red WiFi llamada "Netro_IRC_xxx"). Por favor no conecte su teléfono a esta red Netro_IRC_xxx en este momento. Se te pedirá que lo hagas en el paso 8.

B Descargue la aplicación gratuita de Netro y comience a configurar.

Consejo:

Busque " Netro sprite watering " en
Google Play y App Store



La Luz LED

La luz LED de tu Sprite tiene tres estados posibles:

Parpadeando lentamente (encendido por un segundo y apagado por un segundo): esto significa que la unidad está en modo HOST. Esto sucede cuando primero conectas tu Sprite o lo reinicias, e indica que necesita pasar por los pasos de configuración en la aplicación para conectarte a una red WiFi doméstica.

Sólido: esto significa que la unidad está conectada a la red WiFi de su hogar.

Parpadeando rápidamente (encendido durante 0,5 segundos y apagado durante 0,5 segundos): esto sucede cuando configura su unidad por primera vez y no ingresa la contraseña correcta, o cuando pierde su conexión con el servidor en la nube de Netro.

Botón de Reinicio

El botón de reinicio se encuentra debajo de la cubierta y se encuentra junto a las ranuras de cableado del adaptador de AC. Está marcado RST. Necesitarás un alfiler o un objeto largo y delgado para presionar el botón.

Presione brevemente: para restablecer su Sprite a su modo HOST, simplemente presione el botón una vez por menos de 1 segundo. Tu Sprite debería comenzar a parpadear lentamente en unos segundos.

Pulsación larga: para restablecer la unidad a la configuración de fábrica, mantenga presionado el botón durante 6-8 segundos. Espere 1-2 minutos, la luz de su Sprite debería comenzar a parpadear lentamente.

SPRITE

智能灌溉控制器

用户指南

- 简体中文 -

这就是未来的智能灌溉系统

包装内含部件



控制器



用户手册

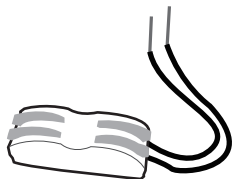

电线连接器



2个螺丝钉

安装前的准备工作

- 1** 首先用现有的控制器测试你的灌溉系统是否能正常工作。如果不能正常工作，请在安装Sprite之前修复你的灌溉系统。

注意：如果你不确定你的灌溉系统是否正常，可通过检查水阀控制线路是否短路或断路来确认设备状况。你只需要用一个万用表来测量共用线（通常为白色）和每个区域之间的电阻，正常读数为20-60欧姆。如果读数小于10欧姆，那么对应的螺线管水阀中可能存在短路；如果读数大于80欧姆，则可能存在断路。请联系我们或专业技术人士以获得额外支持。

- 2** 拔掉当前控制器的电源。

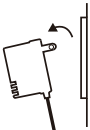

- 3** 拍一张旧控制器的线路连接照片。当你链接Sprite控制器时，这张照片可以作为参考。

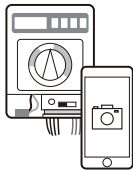

- 4** 移除旧的控制器。

安装

- 1 检查Sprite所安装位置的WiFi信号强度。
建议该WiFi在你手机上的信号强度至少为两格。

注意：Sprite无法连接Wireless b (11Mbps)路由器。Sprite仅支持较新的无线标准，即无线-n、无线-g和无线-ac。Sprite与5 GHz Wi-Fi网络不兼容。

另外，请确保SSID(家庭无线网络的名称)和密码不包含空格或引号之类的特殊字符。

- 2 从Sprite底座上移除前盖。



- 3 使用两个附送的螺丝将Sprite底座安装在墙面上。观察平衡杆内气泡是否处于中间位置以确认控制器是否位于水平位置。

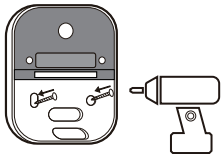

连接电线

4 将电线重新连接到Sprite控制器底座的端口内

提示：

1. 拍一张旧控制器的线路连接图，此图可作为参考。
2. 将主阀连接到“M”端口。在有些控制器中，主阀端口可能会被标记为“PMV”和“P/MV”。如果你没有主阀或者水泵，“M”端口可以不使用。
3. 如果旧的控制器的只有一根公共导线，你可以将它连接到其中一个“C”端口，另一个“C”端口可以不使用。
4. 如果你想继续使用带有地线的旧电源适配器，你可以不连接此地线。
5. 如果旧的控制器的连接了一个有线的降雨传感器，你没有必要连接这个传感器的线到Sprite，因为Sprite是通过无线网络来获取天气数据。

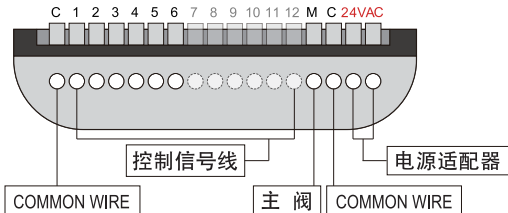

如果您不确定如何连接线路，请将旧控制器的线路图发送到support@netrohome.com。

我们的客户服务中心将及时为您提供支持。

连接电线

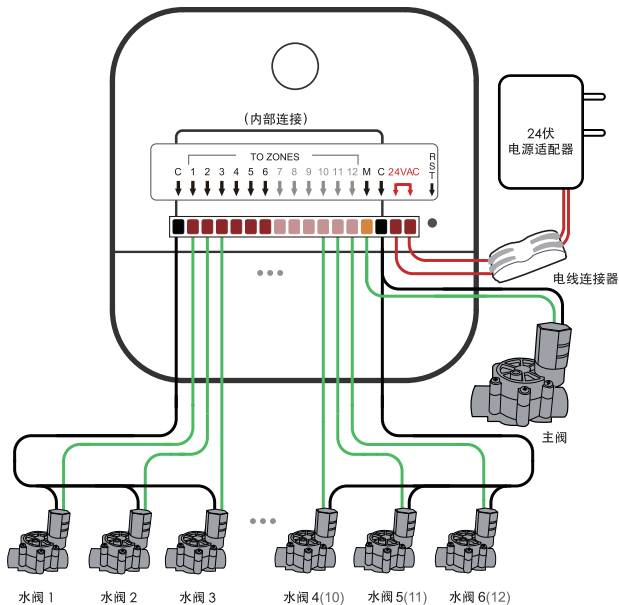

安装

5 将前盖装回控制器底座。



6 插入电源。等待1-2分钟，指示灯将缓慢闪烁（每秒一次）。如果指示灯常亮或快速闪烁（每秒两次），请按下RST按钮。

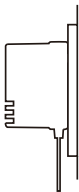

7 Sprite的网络将会处于HOST模式（您将看到名为“Netro_IRC_xxx”的WiFi网络）。现在请先不要连接你的手机到该Netro_IRC_xxx网络，你会在步骤8中进行此操作。

8 免费下载安装Netro应用程序并开始配置。

提示：

可通过Google Play和App Store上搜索“Netro sprite watering”找到“Netro”应用软件。

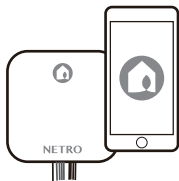

LED灯状态

控制器Sprite上的LED灯存在三种可能的状态：

慢速闪烁（亮暗周期为2秒）：这表示设备正在等待被配置网络（我们称之为设置模式）这种情况发生于当您首次安装Sprite控制器时或将其重置时，这表明需要经过配置才能连接到家庭WiFi网络。

常亮：设备成功连接于您的家庭WiFi。

快速闪烁（亮暗周期为1秒）：当您首次配置设备但没有输入正确的密码时，或者设备与Netro云服务器断开连接时这种状况会发生。

重置按钮

重置按钮位于控制器前盖下面，与交流适配器接线端口相邻。它被标记为RST。你将需要一个针或细长的物体来按下重置按钮。

短按重置键：轻触（1秒以内）重置键可将设备切换为配置模式，控制器会在几秒钟内开始慢速闪烁。

长按重置键：长按（6~8秒）重置键可将设备恢复为出厂状态，等待1-2分钟，控制器会开始慢速闪烁。

SPRITE

Intelligente Bewässerungssteuerung

Schnellstartanleitung

- Deutsch -

Lernen Sie das Bewässerungssystem der Zukunft kennen

Inhalt



Steuergerät

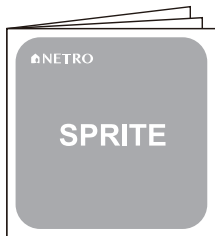

Bedienungsanleitung

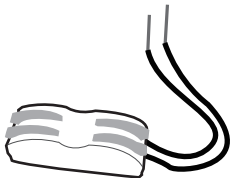

Kabelverbinder

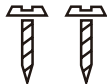

2 Schrauben

Vorbereitung

- 1 Testen Sie zunächst die Funktionsfähigkeit Ihres Bewässerungssystems mit Ihrem derzeitigen Steuergerät. Sollte es nicht funktionieren, lassen Sie es bitte vor Installation des Sprite reparieren.

Hinweis: Falls Sie sich hinsichtlich des Zustands Ihres Bewässerungssystems nicht sicher sind, überprüfen Sie, ob es kurzgeschlossene oder offene Zonen gibt. Sie müssen lediglich ein Multimeter benutzen, um den Widerstand zwischen dem gemeinsamen Leiter (im Allgemeinen weiß) und jeder Zone zu messen. Im Normalfall sollte das Messergebnis 20-60 Ohm betragen. Wenn das Ergebnis weniger als 10 Ohm beträgt, könnte ein Kurzschluss in der Magnetspule vorliegen. Bei mehr als 80 Ohm könnte ein offener Stromkreis vorliegen. Bitte kontaktieren Sie uns oder einen Bewässerungsexperten für weitere Unterstützung.

- 2 Ziehen Sie den Stecker Ihres derzeitigen Steuergeräts heraus.
- 3 Machen Sie ein Foto von der Verdrahtung Ihres alten Steuergeräts. Nutzen Sie es als Vorlage, wenn Sie Sprite verdrahten.
- 4 Entfernen Sie Ihr derzeitiges Steuergerät.

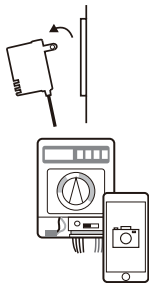

Installation

- 1** Überprüfen Sie die Stärke des WLAN-Signals dort, wo Ihr Sprite installiert wird.
Wir empfehlen mindestens zwei Signalbalken auf Ihrem Telefon.

Hinweis: Sprite lässt sich nicht mit WLAN-B-Routern (11Mbps) verbinden. Sprite unterstützt lediglich die neueren Standards, nämlich WLAN-N, WLAN-G und WLAN-AC. Sprite ist nicht mit 5 GHz WLAN-Netzwerken kompatibel.
Stellen Sie bitte auch sicher, dass Ihr SSID (der Name Ihres WiFi-Heimnetzwerks) und das Passwort keine Sonderzeichen wie Leerzeichen oder Anführungszeichen enthalten.

- 2** Entfernen Sie die vordere Abdeckung des Geräts.



- 3** Installieren Sie das Sprite-Gerät mithilfe der zwei mitgelieferten Schrauben an der Wand.

Verwenden Sie eine Wasserwaage für eine horizontale Position.

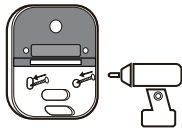

Verdrahtung

4 Verbinden Sie die Leitungen wieder mit den Anschlüssen in Ihrem Sprite.

Tipps:

1. Verwenden Sie das Foto mit der Verdrahtung Ihres alten Steuergeräts als Erinnerungshilfe.
2. Der Steckplatz mit der Markierung „M“ ist für das Hauptventil bzw. die Pumpe. Bei einigen Steuergeräten ist er mit „PMV“ oder „P/MV“ gekennzeichnet. Wenn Sie kein Hauptventil bzw. keine Pumpe haben, können Sie den Steckplatz „M“ frei lassen.
3. Wenn das alte Steuergerät nur einen gemeinsamen Leiter hat, können Sie ihn mit einem der „C“-Steckplätze verbinden und den anderen „C“-Steckplatz freilassen.
4. Wenn Sie Ihr altes Netzteil mit einem Erdungsdraht verwenden möchten, können Sie den Erdungsdraht offen lassen.
5. Wenn das alte Steuergerät mit einem Regensensor verbunden ist, brauchen Sie die entsprechenden Leitungen des Sensors nicht zu verbinden, da Ihr Sprite Wetterinformationen über das WLAN-Netzwerk bezieht.

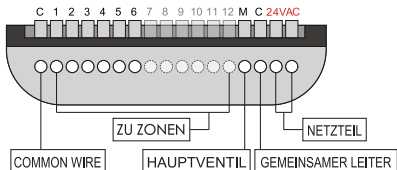

Sollten Sie sich hinsichtlich der Verdrahtung nicht sicher sein, senden Sie uns bitte das Foto der Verdrahtung des alten Steuergeräts an support@neotrohome.com. Unser Kundendienst unterstützt Sie gerne.

Einrichtung

5 Bringen Sie die vordere Abdeckung wieder an.



6 Schließen Sie das Gerät an. Warten Sie 1-2 Minuten, solange die Lampe langsam blinkt (einmal pro Sekunde). Leuchtet die Lampe dauerhaft oder blinkt sie schnell (zweimal pro Sekunde), drücken Sie bitte den RST-Knopf.

7 Das Netzwerk Ihres Sprites ist nun im HOST-Modus (Sie werden ein WiFi-Netzwerk „Netro_IRC_xxx“ sehen). Verbinden Sie Ihr Telefon bitte noch nicht mit dem Netzwerk „Netro_IRC_xxx“. Dies folgt erst in Schritt 8.

8 Laden Sie die kostenlose Netro-App herunter und beginnen Sie mit der Konfiguration.

Tipp:

Suchen Sie nach „Netro sprite watering“ bei Google Play und im App Store.

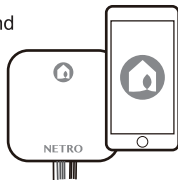

Die LED-Lampe

Die LED-Lampe Ihres Sprite hat drei mögliche Signale:

Langsames Blinken (eine Sekunde ein, eine Sekunde aus): Dies bedeutet, dass das Gerät im HOST-Modus ist. Das passiert, wenn Sie es zum ersten Mal anschließen oder es zurücksetzen. Dies deutet darauf hin, dass es den Einrichtungsprozess in der App durchlaufen muss, um sich mit einem WiFi-Heimnetzwerk zu verbinden.

Dauerhaftes Leuchten: Dies bedeutet, dass das Gerät mit Ihrem WiFi-Heimnetzwerk verbunden ist.

Schnelles Blinken (0,5 Sekunden ein, 0,5 Sekunden aus): Dies passiert, wenn Sie das Gerät erstmalig einrichten und ein falsches Passwort eingegeben haben oder wenn das Gerät seine Verbindung zum Netro Cloud Server verliert.

Der Reset-Knopf

Der Reset-Knopf befindet sich unterhalb der Abdeckung und liegt neben den AC-Netzteil-Steckplätzen. Er ist mit RST markiert. Sie benötigen eine Nadel oder ein ähnliches dünnes, langes Objekt, um den Knopf zu drücken.

Kurzes Drücken: Um Sprite in den HOST-Modus zurückzusetzen, drücken Sie den Knopf einfach kürzer als eine Sekunde. Ihr Sprite sollte nach wenigen Sekunden anfangen, langsam zu blinken.

Langes Drücken: Um die Werkseinstellungen wiederherzustellen, halten Sie den Knopf für 6-8 Sekunden gedrückt. Die Lampe an Ihrem Sprite sollte nach 1-2 Minuten anfangen, langsam zu blinken.

SPRITE

Smart Watering Controller

Avvio rapido della guida

- Italiano -

Si incontra il sistema di irrigazione del futuro

Contenuti



Controller



Istruzioni

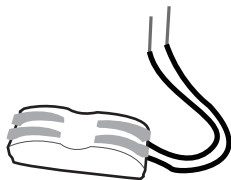

Cavo connettore

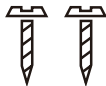

2 Viti

Preparazione

- 1** Si testa prima la funzionalità del proprio sistema di irrigazione con il tuo attuale controller. Se non funziona, assicurati che venga riparato prima di montare Sprite.

Nota: se non si è sicuri delle condizioni del tuo sistema di irrigazione, è possibile verificare se vi sono zone in cortocircuito o zone aperte. Hai solo bisogno di usare un multimetro per misurare la resistenza tra il conduttore comune (di solito bianco) e ogni zona. La lettura normale sarebbe 20-60 Ohm. Se la lettura è inferiore a 10 Ohm, si potrebbe avere un corto circuito nel solenoide e se è maggiore di 80 Ohm potrebbe avere un circuito aperto. Si prega di contattare noi o professionisti dell'irrigazione per ulteriore supporto.

- 2** Scollega il cavo di alimentazione del tuo attuale controller.

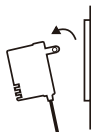

- 3** Scatta una foto del cablaggio nel tuo vecchio controller. Quando stai collegando il Sprite, questa foto può essere il riferimento.



- 4** Rimuovi il tuo attuale controller.

MONTAGGIO

- 1** Controlla la potenza del segnale WiFi nella posizione in cui verrà montato il tuo Sprite.
Si consiglia un segnale di almeno 2 barre sul telefono.

Nota: Il Sprite non è in grado di connettersi ai router Wireless-B (11Mbps). Il Sprite supporta solo i nuovi standard, ovvero Wireless-N, Wireless-G e Wireless-AC. Il Sprite è incompatibile con le reti Wi-Fi a 5 GHz.
Inoltre, si assicura che il SSID (nome di Wi-Fi della tua casa) e la password non contiene i caratteri speciali come spazi o virgolette.

- 2** Rimuovi il coperchio anteriore dalla base.



- 3** Monta la base del Sprite sulla parete con le due viti incluse. Usa la bolla d'aria per posizionarla orizzontalmente.

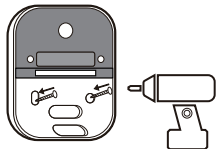

Cablaggio

4 Ricollega i conduttori ai terminali sulla base del tuo Sprite.

Suggerimenti:

1. Usa l'immagine dei conduttori sul tuo vecchio controller per aiutarti a ricordare.
2. Lo slot denominato "M" è per la valvola principale o la pompa. In alcuni controller è denominato "PMV" o "P / MV". Se non si dispone di una valvola principale o di una pompa, è possibile lasciare questo slot "M" scollegata.
3. Se il vecchio controller ha un solo conduttore comune, è possibile collegarlo a uno degli slot "C" e l'altro slot "C" si siederà vuoto.
4. Se si desidera utilizzare il vecchio adattatore con un filo di messa a terra, è possibile lasciare aperto il filo di messa a terra.
5. Se il vecchio controller è collegato a un sensore pioggia, non è necessario collegare i conduttori del sensore perché lo Sprite riceve le informazioni meteorologiche dalla rete WiFi.

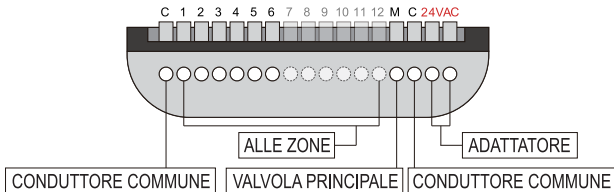

Se non si è sicuri del cablaggio, si prega di inviare l'immagine del cablaggio nel vecchio controller a support@netrohome.com. Il nostro servizio fornirà il supporto rapidamente .

Cablaggio

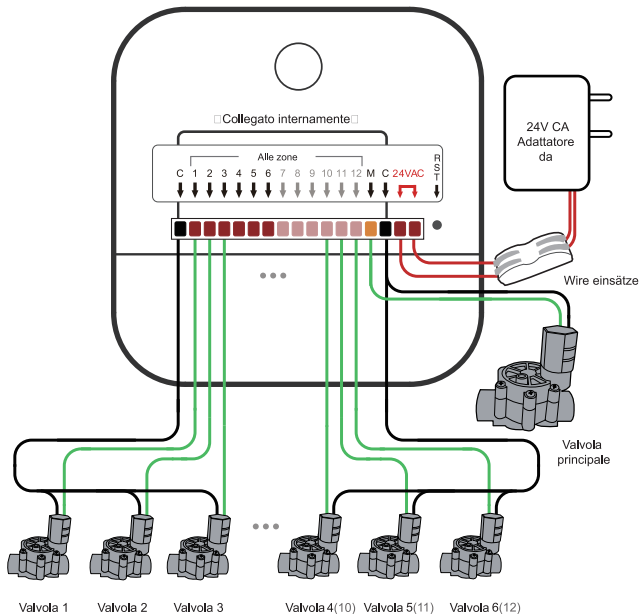

Sistemazione

5 Rimetti il coperchio anteriore sulla base.

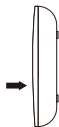

6 Collega il potere. Attendi 1-2 minuti, la luce lampeggerà lentamente (una volta per secondo). Se la luce è stabile o lampeggia velocemente (due volte per secondo), premi il pulsante RST.

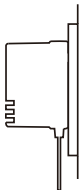

7 La rete del tuo Sprite sarà nella sua modalità HOST (vedrai una rete WiFi denominata "Netro_IRC_xxx"). Si prega di non collegare il telefono a questa rete Netro_IRC_xxx in questo momento. Ti verrà chiesto di farlo al punto 8.

8 Scarica la Netro APP gratuita e inizia a configurare.

Suggerimenti:

Cerca "Netro sprite watering" su Google Play e App Store.

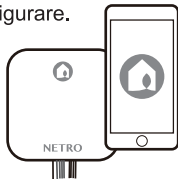

La luce a LED

La luce LED sul tuo Sprite ha tre possibili stati:

Lampeggia lentamente (acceso per un secondo e spento per un secondo): questo significa che l'unità è nella sua modalità HOST. Questo accade quando si collega lo Sprite per la prima volta o si resetta, e indica che è necessario eseguire i passaggi di configurazione nell'APP per connettersi a una rete WiFi della tua casa.

Solido: questo significa che l'unità è connessa al WiFi della tua casa.

Lampeggia rapidamente (acceso per 0,5 secondi e spento per 0,5 secondi): Questo accade quando si imposta la propria unità per la prima volta e non si immette la password corretta o quando perde la connessione al Netro cloud server.

Il pulsante di reset

Il pulsante di reset si trova sotto il coperchio e accanto allo slot di cablaggio dell'adattatore CA. È contrassegnato come RST. Avrai bisogno di un perno o di un oggetto lungo e sottile per premere il pulsante.

Il premere breve: per reset il tuo Sprite alla sua modalità HOST, basta premere il pulsante una volta per meno di 1 secondo. Il tuo Sprite dovrebbe iniziare a lampeggiare lentamente in pochi secondi.

Il premere lungo: per reset l'unità alle impostazioni di fabbrica, tieni premuto il pulsante per 6-8 secondi. Aspetta 1-2 minuti, la luce sul tuo Sprite dovrebbe iniziare a lampeggiare lentamente.

SPRITE

Controlador de Rega Inteligente

Guia de partida rápido

- Português -

Conheça o Sistema de Rega do Futuro

Conteúdo



Controlador



Instruções

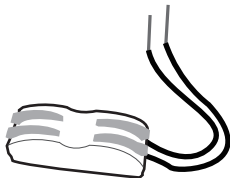

Connector de Fio

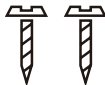

2 parafusos

Preparação

- 1** Teste a funcionalidade do seu sistema de irrigação primeiro com o seu controlador atual. Se não funcionar, por favor, certifique-se de que ele seja reparado antes de instalar o Sprite.

Nota: Se você não tiver certeza sobre a condição do seu sistema de sprinklers, pode querer verificar se existem zonas encurtado ou zonas aberto. Você só precisa usar um multímetro para medir a resistência entre o fio comum (geralmente branco) e cada zona. A leitura normal seria 20-60 Ohms. Se a leitura for inferior a 10 Ohms, então você pode ter um curto circuito no solenóide e se for maior do que 80 Ohms você pode ter um circuito aberto. Por favor, contacte-nos ou contacte profissionais de irrigação para suporte adicional .

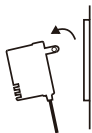

- 2** Desconecte o cabo de energia do seu controlador atual.

- 3** Tire uma foto da fiação no seu antigo controlador. Quando você estiver ligando o Sprite, esta foto pode ser a referência.



- 4** Remova o seu controlador atual.

Instalação

- 1** Verifique a intensidade do sinal Wi-Fi no local onde o seu Sprite será instalado. Recomendamos um sinal de pelo menos 2 bares no seu telefone.

Nota: o Sprite é incapaz de se conectar a roteadores de redes Wireless-B (11Mbps). O Sprite só suporta os novos padrões, nomeadamente , o Wireless-N, Wireless-G e o Wireless-AC. O Sprite é incompatível com redes de WI-FI 5 GHz.

Por favor, certifique-se de que o SSID (nome da sua casa Wi-Fi) e a senha não contém espaços ou caracteres especiais como aspas.

- 2** Remova a tampa frontal da base.



- 3** Instale a base de Sprite na parede usando os dois parafusos incluídos. Use a bolha de ar para a posição horizontal.

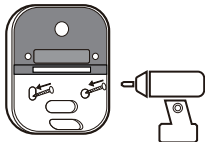

Fiação

4 Reconecte os fios aos terminais na base do seu Sprite.

Dicas:

1. Use a imagem dos fios no seu controlador antigo para ajudá-lo a se lembrar.
2. O slot chamado "M" é para a válvula principal ou a bomba. Em alguns controladores é nomeado como "VMP" ou "P/MV". Se você não tiver uma válvula principal ou uma bomba, você pode deixar este "M" alheio.
3. Se o controlador antigo tem apenas um fio comum, você pode conectá-lo a um dos slots "C" e o outro "C" ficará vazio.
4. Se você quiser usar o adaptador de energia velha que tem um fio terra, você pode deixar o fio terra aberto.
5. Se o antigo controlador estiver conectado a um sensor de chuva, você não precisa conectar os fios do sensor porque seu Sprite obtém informações sobre o clima a partir da rede WiFi.

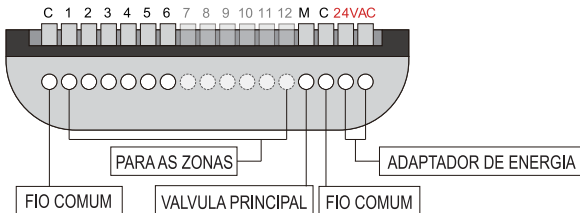

Se você não tem certeza sobre a cablagem, favor envie a foto da cablagem no antigo controlador para o Support@netrohome.com.
O nosso serviço ao cliente irá fornecer rápido suporte.

Fiação

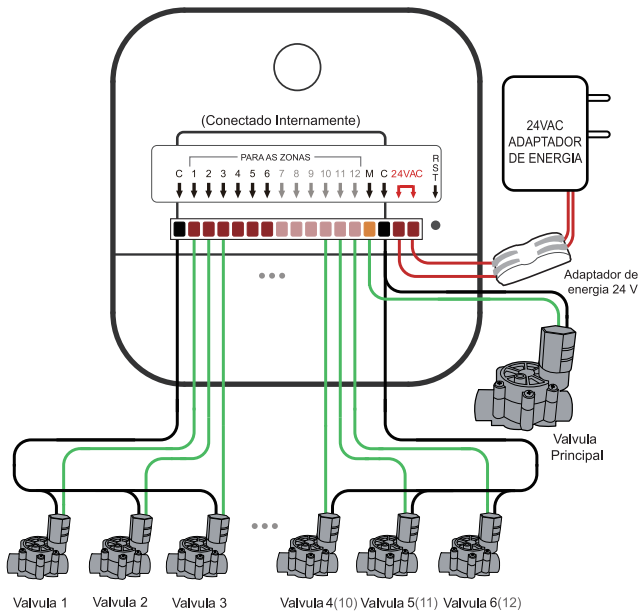

Configuração

5 Coloque a tampa da frente na base.



6 Ligue a energia. Aguarde 1-2 minutos, a luz irá piscar lentamente (uma vez a cada segundo). Se a luz estiver estável ou piscando rapidamente (duas vezes por segundo), pressione o botão RST.

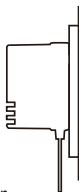

7 A rede do seu Sprite estará no modo HOST (você irá ver uma rede WiFi chamada "Netro_IRC_xxx"). Por favor, não conecte seu telefone a esta rede Netro_IRC_xxx agora. Você será solicitado a fazê-lo na etapa 8.

8 Baixe o aplicativo Netro gratuito e comece a configurar.

Dicas:

Procure por "Netro sprite watering" no Google Play e na App Store.

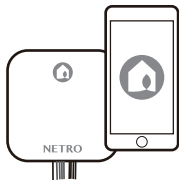

A Luz de Led

A luz LED no seu Sprite tem três estados possíveis:

Piscando lentamente (ligado por um segundo e desligado por um segundo): Isso significa que a unidade está no modo HOST. Isso acontece quando você conecta seu Sprite pela primeira vez ou o redefine e indica que ele precisa passar pelas etapas de configuração no aplicativo para se conectar a uma rede Wi-Fi doméstica.

Sólido: Isso significa que a unidade está conectada ao seu WiFi doméstico.

Piscando rapidamente (ligado por 0,5 segundo e desligado por 0,5 segundo): Isso acontece quando você configura sua unidade pela primeira vez e não insere a senha correta, ou sempre que perde sua conexão com o servidor da nuvem Netro.

O botão Reset

O botão de reinicialização está localizado embaixo da tampa e fica ao lado dos slots de fiação do adaptador de CA. Está marcado como RST. Você precisará de um alfinete ou um objeto longo e fino para pressionar o botão.

Pressione rapidamente: para redefinir seu Sprite para o modo HOST, basta pressionar o botão uma vez por menos de 1 segundo. Seu Sprite deve começar a piscar lentamente em alguns segundos.

Pressão longa: para redefinir a unidade para as configurações de fábrica, mantenha o botão pressionado por 6 a 8 segundos. Espere por 1-2 minutos, a luz no seu Sprite deve começar a piscar lentamente.



Netro INC.